

An Innovative Approach of Renewable Energy Management Using Fuzzy Technique

Nesar Uddin¹, Saiful Islam², Tazul Islam², Yingjun Wu¹, Al Mamun³, Jewel Sikder Joy²

¹ Hohai University, Nanjing, China

² Chittagong University of Engineering and Technology (CUET), Chattogram-4349, Bangladesh

³ University of Bremen, Germany

(Received 21 March 2021; revised manuscript received 15 June 2021; published online 25 June 2021)

This research article represents a method of the intellectual power management optimization that integrates renewable sources with battery backup using fuzzy technique. The developed fuzzy controller monitors the continuous variations of the energy of selected renewable sources and load demand for the energy management systems. Then FLC shifts to provide electricity into the load allows for fuzzy instructions for efficient power supply. Here, the fuzzy rule has been developed from human thinking with the highest priority of renewable energy to electric load in any time of a day. When the load demand is full, the excess power will be charged to the battery. Again, if at any time of the day, the power generation from renewable energy is less, then the stored electricity in the battery will act as a backup system to load. Lastly, if at any time of the day the load demand and the condition of the battery charge are full, even if the renewable energy remains, it is arranged to be given to the dummy load. The system has been built where electricity has not yet been reached. The simulation results show that a properly constructed fuzzy rule can work 24 h a day for any difficult situation where the nonlinear function has been used. The whole system is very environmentally friendly where no harmful gas is emitted.

Keywords: Energy management optimization (EMO), Fuzzy technique, Solar energy, Wind energy.

DOI: [10.21272/jnep.13\(3\).03023](https://doi.org/10.21272/jnep.13(3).03023)

PACS numbers: 88.05.Ec, 88.05.Rt, 88.40. -j, 88.50. -k

1. INTRODUCTION

Electricity in the development of all fields in the modern world. Again, the most used in this power generation is nonrenewable energy which is limited and release of harmful gases as well yet greenhouse affect [1]. So, the whole world is moving towards new technologies of renewable energy for the purpose of power generation. Moreover, renewable energy does not harm the environment. Present-day, about 1.2 TW hydroelectric energy is used out of the 3 TW. Through biomass energy to fulfill total load demand, about 31 % of the land is required on earth [2]. Therefore, this energy resource is not suitable for electricity generation. The wind power system is asymmetrical and comparatively unusual which is used about 0.6 TW power in 25-70 TW range. The use of geothermal energy is quite low that is about 1 TW out of 13.5 GW. But the energy from the sun is obtainable for a long period. The use of sunlight on the ground is around 125,000 TW [3]. That is concluded 6,000 times more than the world energy request. So, solar energy is the best option for electricity.

At present, Bangladesh is more applicable for solar energy, small-scale hydropower, biofuel energy, and wind energy [4]. Among them, the solar resource is more effective in the entire region with around 4 to 6 kWh solar irradiation and 250 to 300 in the daytime in twelvemonth that can relieve the entire load request of a household in that state [5]. Some coastal areas of Bangladesh are very conducive to wind power generation, where our government can take various steps to generate electricity by installing turbines [6]. As a result, the electricity demand will be less on the one hand and, the environment will be protected from various bad gases on the other hand. Again, these areas also applicable not only wind energy but also solar energy at a

time. So, we can fulfill total load demand of this area by using solar and small-scale wind technology which must decreases the load pressure on the national grid.

The poor energy management system is a noticeable problem in Bangladesh as well as all over the world because we cannot bring out the highest power by traditional method. A big amount of energy is missing in the transmission and distribution line. Accordingly, to minimize power loss, the fuzzy control technique is applied for feasible EMS. Therefore, to progress an effective energy managing structure, the fuzzy control technique has been used in this paper.

2. METHODOLOGY

2.1 Overall System's Block Diagram

Recommended energy management structure consists of PV modules, AC wind turbines, storage system which is revealed in Fig. 1. The PV modules and wind turbine are the major foundations of power then extra power is stowed into batteries to satisfy the energy request during the times of no origination from the main sources allowing desired fuzzy rules. The output power of PV modules is DC which is varies with solar irradiation or random environmental effects. So, a DC/DC step-up converter is used to obtain a stable DC power. Besides, the output power of the wind turbine is AC which fluctuates with regard to time for the mutation of wind velocity. Therefore, an AC/DC converter is applied to match with FLC, and another DC/DC boost converter is used to obtain stable voltage as well as supreme power from the wind turbine. The dummy load is a kind of machine which is applied for testing purpose to emulate an electric load. Since, this system has been developed for stand-alone in where grid is not available, so dummy load is required for testing system.

The results were presented at the International Conference on Innovative Research in Renewable Energy Technologies (IRRET-2021)

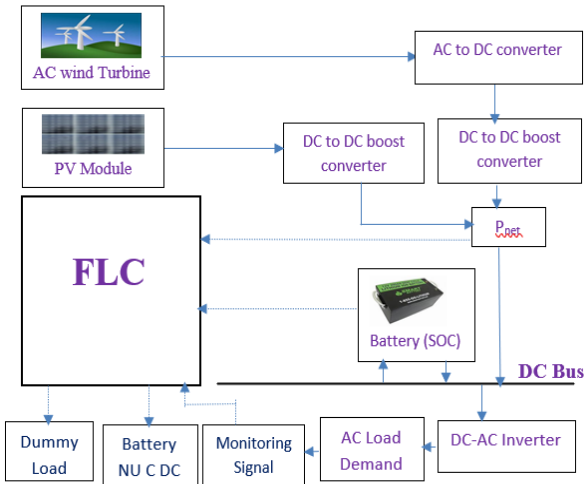

Fig. 1 – Suggested structure's block-diagram

2.2 Solar Energy Conversion System

Solar power is the process of converting light from the sun into electricity through a semiconductor device [7]. Below the thin glass plate of the solar panel is a layer of silicone which looks black from the outside [8]. This silicone layer has two edges, positive and negative. When protons come from sunlight, they excite the negative side. Then the neutrons on this negative side are attracted to the positive side [8]. The whole process takes place through magnetic flux. Then if the circuit is completed, then electricity flows. The basic formula for finding the total current I flowing through a solar panel is given below [9]:

$$I = N_p I_{PV} - N_p I_0 \left(\exp \frac{q(V + R_s I)}{N_s AKT} - 1 \right) - \frac{(V + R_s I)}{R_{sh}} \quad (1)$$

In the above equation, N_p is the number of parallel cells, I_{PV} is the PV cell current in amp, V is the voltage across the load in volt, R_s is the series resistance in Ω , R_{sh} is the shunt resistance in Ω , T is the solar module working temperature in Kelvin, N_s is the number of cells connected in series, K is the Boltzmann constant equal to $1.3805 \cdot 10^{-23}$ J/K, A is the ideality factor equal to 1.6, and I_0 is the saturation current of PV module in amp.

2.3 Wind Energy Conversion System

Wind bases turbine is a rotating device that propagates electrical power from wind speed to kinematic energy [10]. There are two kinds of viz; one is horizontal-axle wind turbine, whose blade rotates in horizontal position, and another is vertical-axle wind turbine whose blade rotates in vertical position with earth level. Among them, the horizontal-axle turbine is excessive appropriate for gathering supreme power in a day. Its designing blade can handle billowy wind speeds [11]. Therefore, the horizontal axle wind turbine is probably more comfortable for producing much electricity than others. Thus, the original mechanical power ability can be figured by the below equation [12]:

$$P_t = C_{pa} \frac{1}{2} \rho_a A v^3, \quad (2)$$

where the wind velocity is denoted by v in meter per second, and the power coefficient is denoted by C_{pa} .

For EMO, small size 2.5 kW WES5 Tulipo wind turbine has been selected so that it can handle heavy air density of the remote area and can produce electricity in less air density. This kind of turbine has some advantages yet, it creates poor sound and oscillation [13]. It does not need more maintenance and fully automatic.

2.4 Energy Management Approach

The proposed energy management (EM) is advanced owing to houses, so that, five or else six-person lives in every family through 120 square meters of living place. Various electrical applications are connected in every house. The nominated appliance has been designed for 220 V AC voltage, 50 Hz frequency. Table 1 describes the rating of an electric device of households with two bedrooms, one kitchen, two bathrooms and a corridor.

Table 1 – Electric equipment of a house

Appliances	Number of appliances	Watt rating of every appliance in watt	Total watt rating of every appliance in watt	Watt hours /day
CFL lamps	12	25	300	12
Refrigerator	1	200	200	8
Ceiling fan	6	60	360	10
Television	1	150	150	8
Electronic charger device	5	10	50	10

Suggested power management structure has been advanced by depending on fuzzy logic performance viz Mamdani interface method. To ensure highest and effectual output to management system, fuzzy logic technique is applied in this study. The main objectives of recommended structure are to satisfy the conditions marked below.

- PV modules as well as wind turbines act as main sources of energy production.
- Battery performances work as a supplementary energy reservoir.
- The load request must be satisfied regardless of the period.
- The control method as well as charging and the discharging system depend on load request and obtainable power.

The suggested energy management optimization consisting of three types of input and doublet outputs those are exposed in Fig. 2. The tierce inputs are totality of bringing power from renewable foundations which is denoted as P_{net} , state of charge which is denoted as SOC and load demand that denoted as LD. Entire inputs have tierce triangular membership functions like low, medium, high exposed respectively in Fig. 3, Fig. 4, Fig. 5. The two-output membership functions are battery-NU-C-DC (have three membership functions, those are denoted as S1, S2, S3) and dummy load ON-OFF (have two membership functions, those are denoted as S1, S2). The range of membership function of battery has been considered (0 to 95 %) so that the battery does not reach full charge as well as 100 %. If the battery reaches 100 %, then the lifetime of the battery will be minimized and damage as soon. Again,

at the time of discharge of the battery, it will not reach 0 % because of designed fuzzy rule. Fuzzy rules have been developed in order that the discharge rate of the battery is crossed the range of lower membership function, then it will be stopped automatically.

An optimization operating software (HOMER) has been contributed to calculating the optimum size of the system's components as well as PV module, wind turbine (2.5 kW WES5 Tulipo wind turbine) and battery (6 V, 6.94 kWh 6CS25P) for the energy management optimization.

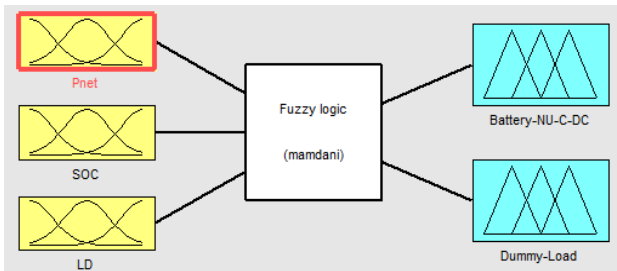

Fig. 2 – Block diagram of suggested fuzzy based EMS

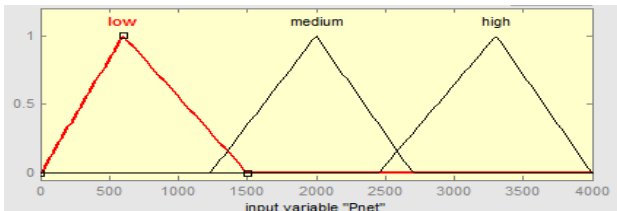

Fig. 3 – Membership functions of produced power, P_{net} in watts

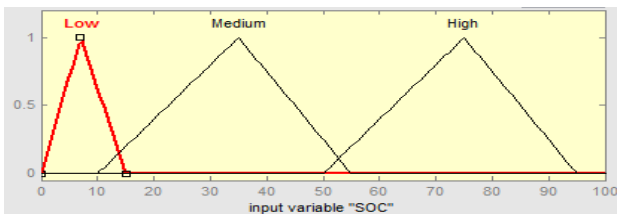

Fig. 4 – Membership functions of SOC in percent %

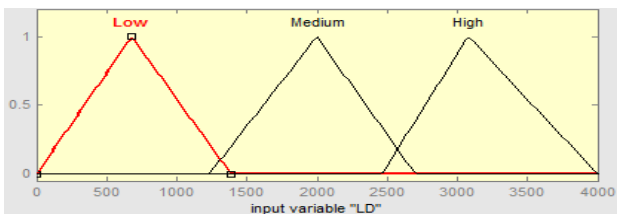

Fig. 5 – Membership functions of LD in watts

FLC anticipates with inputs and outputs which acts based on IF-THEN statements. IF part is recognized as the input section and THEN part is recognized as the output section. In this study, overall, 24 rules have been considered for various operating conditions those are presented in Table 2.

Table 2 – Fuzzy rules for EM

Rules No	IF			THEN	
	$P_{net} = P_{pv} + P_{wind}$	SOC	LD	Battery	Dummy Load
1-9	L/M/H/ L/M/H/ L/M/H	L/L/L/ M/M/M/ H/H/H	L/L/L/ L/L/L/ L/L/L	S1/S2/S2 /S1/S2/S 2/S1/S1/ S1	S1/S1/S1/ S1/S1/S1/ S1/S2/S2
10-17	M/H/L/ M/H/L/ M/H	L/L/M/ M/M/H/ H/H	M/M/ M/M/ M/M/ M/M	S1/S2/S3 /S1/S2/S 3/S1/S1	S1/S1/S1/ S1/S1/S1/ S1/S2
18-24	H/L/M/ H/L/M/ H	L/M/M/ M/H/H/ H	H/H/H/ /H/H/ H/H	S1/S3/S3 /S1/S3/S 3/S1	S1/S1 S1/S1/S1/ S1/S1

3. EVALUATION OF ENERGY MANAGEMENT APPROACH

The FLC output for the EMS depends on the execution at any instant. There are about 24 rules developed with three inputs and two outputs.

Case study – A

In Fig. 6, when entire produced power from solar module and wind turbine (P_{net}) is high, SOC of battery is low, LD is low. Then battery has been considered for charging and dummy load has been considered for not use. Because in this step, generated power is available, but SOC of battery is low. So, the first priority is gone to battery for charging.

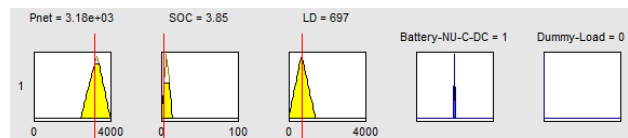

Fig. 6 – When P_{net} -H, SOC-L, LD-L, then battery-charge, dummy load-not use

Case study – B

In Fig. 7, when whole produced power from solar module and wind turbine (P_{net}) is high, SOC of battery is high, LD is low, then battery has been considered for not use and dummy load has been considered for use. Because in this step, generated power (P_{net}) and SOC of battery are available. So, extra energy is gone to dummy load.

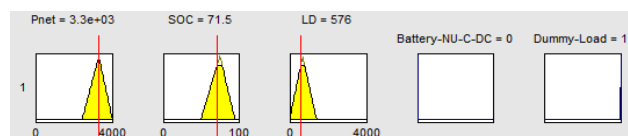

Fig. 7 – When P_{net} -H, SOC-H, LD-L, then battery-not use, dummy load-use

Case study – C

In Fig. 8, when entire produced power from solar module and wind turbine (P_{net}) is medium, SOC of battery is high, LD is high, then battery has been considered for discharging and dummy load has been considered for not use. Because in this step, generated power (P_{net}) from renewable sources is medium and SOC of battery is high. At the same time, load demand is low. So, battery has been considered for discharging.

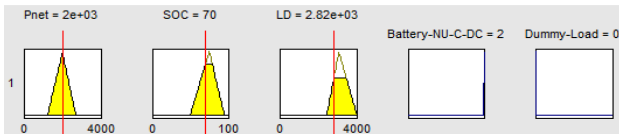

Fig.8 – When P_{net} -M, SOC-H, LD-H, then battery-discharge, dummy load-not use

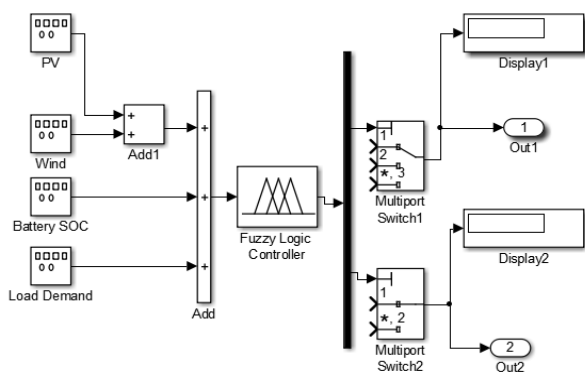

Fig. 9 – Overall hybrid system

4. FUZZY TECHNIQUE BASED EMO

The summation of solar power and wind power (P_{net}), battery SOC and load are the input parameters of fuzzy logic controller. The outputs are battery's switching and dummy load's switching. The power coming from each component is assumed to the random signal generator. The multiport conditional switch will decide according to the rules written in the fuzzy logic controller.

5. CONCLUSIONS

The suggested fuzzy-based energy management structure is intended for coastal areas with RES, storage system, dummy load that has diverse benefits over previously accessible EMS systems. It also inexpensive to build, can manage problems through inexact and imperfect data. Again, overall proposed energy management systems have several advantages. Primarily, the quantity of renewable foundations and load figure is may fixed, i.e., the research is capable of perform at any residence where renewable sources are available. Furthermore, it is possible to increase the efficiency by adapting supplementary intellectual fuzzy rules. Finally, this management structure is more efficient in whither fossil fuel is not available. A major problem with a given system is that the intensity of the sun and the speed of the wind change over time due to which electricity is not available at the right time. However, the fuzzy rules are designed to work in all day situations. As a result, the electricity can be used properly, and the extra power can be given to the dummy load after the battery charging. The whole system is environmentally friendly and does not emit any harmful gases and is much better than the previous conventional process.

REFERENCES

1. Soedibyo, T.A. Hadi, H.P. Putra, H. Suryoatmojo, M. Ashari, *MATEC Web Conf.* **59**, 02001 (2016).
2. M. Gowri, V. Vinothkumar, K. Punitha, *Int. J. Sci. Res. Develop.* **3** No 04, 990 (2015).
3. G.A. Khalil, D.C. Lee, J.K. Seok, *35th Annual IEEE Power Electronics Specialists Conference*, 5 (Aachen: Germany: 2014).
4. M.F. Ansari, S. Chatterji and A. Iqbal, *Int. J. Sustainable Energy* **29** No 4, 245 (2010).
5. N. Uddin, M.S. Islam, *International Conference on Innovations in Science, Engineering & Technology*, 474 (Chittagong, Bangladesh: October 27-28, 2018).
6. R. Islam, N. Rahman, A. Mannan, *Int. Res. J. Eng. Technol.* **03** No 09, 1290 (2016).
7. N. Uddin, M.S. Islam, *International Conference on Innovations in Science, Engineering & Technology*, 474 (Chittagong, Bangladesh: October 27-28, 2018).
8. Rajashri K. Patil, *International Journal of Creative Research Thoughts (IJCRT)* **6** No 2 (2018).
9. N. Uddin, M.S. Islam, *4th International Conference on Electrical Engineering and Information & Communication Technology*, 296 (Dhaka, Bangladesh: September 13-15, 2018).
10. H.J. Wagner, *EPJ Web Conf.* **148**, 00011 (2017).
11. I.M. Albuquerque, F.F.S. Matos, *IEEE Latin America Transactions* **14** No 10, 4255 (2016).
12. Ahadi, X. Liang, W. Li, *53rd Industrial and Commercial Power Systems Technical Conference (I&CPS)* (Niagara Falls, ON, Canada: May 6-11, 2017).
13. N. Uddin, M.S. Islam, *International Conference on Energy and Power Engineering* (Dhaka, Bangladesh: March 14-16, 2019).

Інноваційний підхід до управління відновлюваною енергією з використанням методу нечіткої логіки

Nesar Uddin¹, Saiful Islam², Tazul Islam², Yingjun Wu¹, Al Mamun³, Jewel Sikder Joy²

¹ Hohai University, Nanjing, China

² Chittagong University of Engineering and Technology (CUET), Chattogram-4349, Bangladesh

³ University of Bremen, Germany

У статті представлений метод інтелектуальної оптимізації управління енергією, який об'єднує поновлювані джерела з резервним акумулятором за допомогою методу нечіткої логіки. Розроблений контролер нечіткої логіки відстежує постійні зміни енергії обраних поновлюваних джерел та потреби в навантаженні для систем управління енергією. Потім контролер перемикається на подачу електрики в навантаження, що дозволяє використовувати нечіткі інструкції для ефективного енергопостачання. Було розроблено нечітке правило з найвищим пріоритетом відновлюваної енергії по відношенню до електричного навантаження в будь-який час доби. Коли навантаження буде повним, надлишкова потужність буде акумулюватися в батареї. Якщо ж у будь-який час доби вироблення електроенергії з поновлюваних джерел енергії буде менше, то накопичена в батареї електроенергія буде діяти як резервна система для навантаження. І, нарешті, якщо в будь-який час доби потреба в навантаженні і стан заряду батареї будуть повними, то енергія, яка залишається, буде призначена для передачі фіктивного навантаження. Система побудована там, де ще немає електроенергії. Результати моделювання показують, що правильно побудоване нечітке правило може працювати 24 години на добу для будь-якої складної ситуації, коли використовується нелінійна функція. Вся система дуже екологічна і не виділяє шкідливих газів.

Ключові слова: Оптимізація управління енергоспоживанням, Метод нечіткої логіки, Сонячна енергія, Енергія вітру.